

IMPORTANT: RECEIVING INSTRUCTIONS: Visually inspect all components for shipping damage. If any shipping damage is found, notify carrier at once.

Shipping damage is NOT covered by warranty. The carrier is responsible for all repair or replacement costs resulting from damage in shipment.

SAFETY FIRST

IMPORTANT—USER SAFETY AND PROTECTION: In setting up systems to fit your operations, care must be taken to select the proper components and design to insure appropriate integration with your operations and existing equipment and that all safety measures have been taken to avoid the risk of personal injury and property damage from your application or system.

GARDNER BENDER CAN NOT BE RESPONSIBLE FOR DAMAGE OR INJURY CAUSED BY UNSAFE USE, MAINTENANCE OR APPLICATION OF ITS PRODUCTS. Please contact GARDNER BENDER for guidance when you are in doubt as to the proper safety precautions to be taken in designing and setting up your particular application. To protect your warranty use only GB/Enerpac hydraulic oil.

Make sure that the highest level of system pressure does not exceed the lowest pressure rating of any component within the system.

The following general instructions and guides will be helpful to determine if your system components are properly connected.

- Be sure all hydraulic connections, hoses, and fittings are rated for the highest pressure your system is capable of generating. Always use hoses and tubing recommended by the hydraulic component manufacturer.
- Be sure all connections are fully tightened. Seal all pipe connections with a high-grade pipe thread sealer.



Teflon tape is an excellent thread sealer. If it is not properly applied, however, pieces may enter the hydraulic system and cause malfunctions and damage. Use 1 1/2 wraps of tape on each thread. Cut off all loose tape ends.

- All connections should be snug and leak-free.



Excessive tightening will strain threads and castings which could cause fitting failure at pressures below rated capacity. **DO NOT** over-tighten any connections.

- Fully tighten hydraulic couplers (avoid excessive force).



Loose couplers will act as a partial or complete line restriction, causing little or no oil flow and resulting in equipment damage or failure.

- Be sure all hydraulic hoses and fittings are connected to the correct **inlet** and **outlet** ports of the pump, cylinder, valves, and other system connections.

PUMP SELECTION

All hydraulic cylinders must be properly connected to the source of hydraulic oil to operate. This source is generally a hand-operated or power-operated pump. The choice of pump will depend upon the requirements of your application. GB has pumps to match cylinders for your applications.

Use the correct pump for the cylinder you have.

RECOMMENDATION: Use hydraulic gauges which indicate safe operating loads in each hydraulic system. Gauges are available for use with all hydraulic components (some gauges have a colored band to indicate load ranges for each cylinder.) **DO NOT** exceed the safe limit of the lowest rated component used within your system.

DO NOT DROP HEAVY OBJECTS ON HOSE

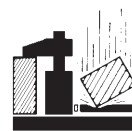

A sharp impact may bend or break internal hose wire strands. Applying pressure to the damaged hose will cause internal flexing which will eventually break the hose strands, rupturing the hose.

DO NOT use the hydraulic hose to carry a hydraulic component (pumps, cylinders, and valves).

DO NOT OVERLOAD CYLINDER



Never attempt to lift a load which exceeds the capacity of a cylinder or jack. Overloading causes equipment failure and possible personal injury.

OFF-CENTER LOADS



Avoid situations where loads are not directly centered on the cylinder plunger. Off-center loads produce considerable strain on cylinder plungers and may slip or fall, causing potentially dangerous results. Avoid point loading—distribute loads evenly across the entire saddle surface.

DO NOT OVEREXTEND CYLINDER



The cylinder will take full load on the plunger stop ring. However, using the full stroke does not supply power and only adds unnecessary strain to the cylinder.

AVOID SHARP BENDS AND KINKS IN HOSE



Avoid sharp bends and kinks when routing hydraulic hoses. If pressure is applied to a bent or kinked hose, the oil flow will be restricted, causing severe back-pressure. Also, the sharp bends and kinks will internally damage the hose, leading to premature failure.

KEEP HYDRAULIC EQUIPMENT AWAY FROM FLAMES AND HEAT



Excessive heat (above 150° F) will soften packings and seals, resulting in fluid leaks. Heat also weakens hose materials and packings. For optimum performance **DO NOT** expose equipment to temperatures of 150° F or higher.

PROVIDE ADEQUATE CLEARANCE



Always provide clearance for hoses and couplers to avoid moving objects, abrasion, or sharp objects.

VALVING: For **Single-Acting** cylinders, use a pump with a 2-way or 3-way valve and one hose.

For **Double-Acting** cylinders, use a pump with a 4-way valve and two hoses.

OIL CAPACITY: Always use a pump that has an oil reservoir capacity sufficient to fully advance or retract your cylinder.

PUMP TYPES

Hand Pumps – Use hand pumps for low speed cylinder applications.

Power Pumps – Use power pumps for applications requiring high speeds and for large cylinders.

Model Number	Type	Pressure Rating (PSI)	Reservoir Capacity (Cu. In.)	Oil Volume Per Stroke (Cu. In.)	Piston Diameter (In.)	Piston Stroke (In.)
PH-39	SINGLE SPEED	0 to 10,000	55.0	.151	7/16	1
PF-65		0 to 6,500	22.0	.16	1/2	13/16
PH-80	TWO SPEED	0 to 350	140.0	.99	1 1/8	1
		350 to 10,000		.15	7/16	
PH-84		0 to 350	140.0	.99	1 1/8	1
		350 to 10,000		.15	7/16	
PH-20		0 to 200	20.0	.221	3/8	1/2
		200 to 10,000		.055	3/4	

SINGLE-ACTING CYLINDERS

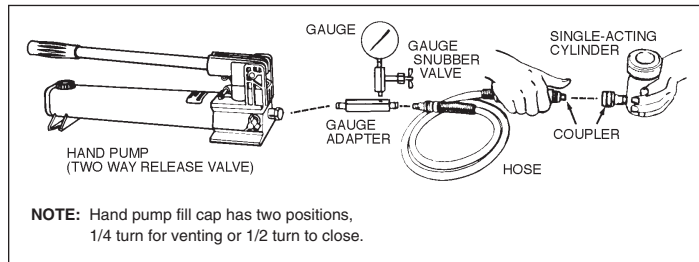

Figure 1
Assembling Single-Acting Hydraulic Cylinders to Pumps
HYDRAULIC HAND PUMPS – Manual 2-way or Manual 3-way Valves

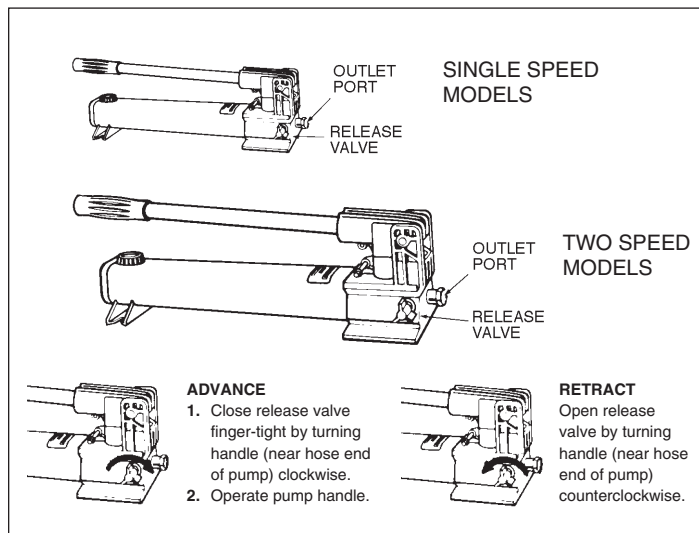

Figure 2
Operating Hydraulic Hand Pumps with Integral Release Valves

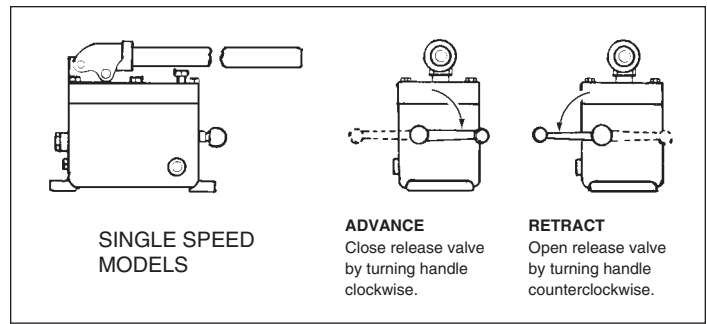

Figure 3
Operating Hydraulic Hand Pumps with External Valves

DOUBLE-ACTING CYLINDERS

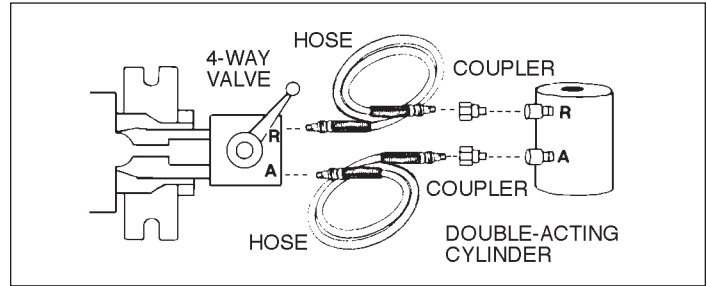

Figure 4
Assembling Double-Acting Hydraulic Cylinders to Pumps
HYDRAULIC HAND PUMP – Manual 4-way Valves

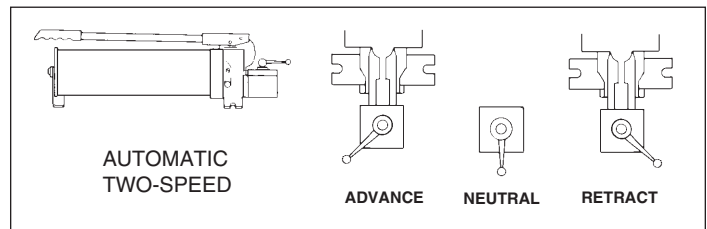

Figure 5
Operating Hand Pumps (Two Speed) with Pump Mounted External Valves

REMOVING AIR

When hoses, cylinders, and other components are connected to build a system, air will be trapped in it. To function properly, the air in the system must be removed. However, the hand pump does require air in the reservoir to prevent a vacuum. If the pump reservoir is totally filled and the vent cap is closed tight, the vacuum created will prevent oil flow out of the pump. Fill reservoirs only to the level indicated on the pump and cap.

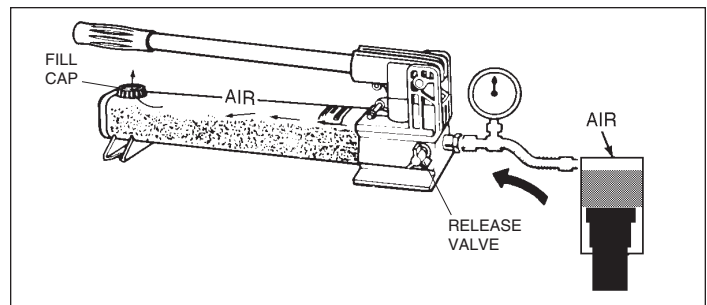

Figure 6
Air In Cylinder Systems

To remove air from a Single-Acting cylinder system:

1. After all system components are connected to the hand pump, check reservoir oil levels. Fill to indicator mark on the end cap. Replace the fill cap and be sure it is closed (not in vent position).
2. Turn pump release valve to closed position. Operate hand pump until cylinder plunger is completely extended.

3. Invert cylinder (plunger end down). Open the pump release valve. As the plunger retracts, the air in the system will be forced into the pump reservoir and replaced by oil. Close the release valve.
4. Turn the cylinder upright. Operate the pump to cycle the cylinder plunger. If air is out of the system, the plunger will advance and retract smoothly. If the plunger is erratic, repeat steps 1 through 4.
5. Open the pump fill cap and check the oil level. Fill to the indicator mark on the end cap.

To remove air from a Double-Acting cylinder:

1. After all system components are connected to the hand pump, check pump reservoir oil level. Fill to the indicator mark on the pump end cap. Replace end cap and turn to the "closed" position.
2. Place hand pump in a place where it will be higher than the hydraulic cylinder. Lay the hydraulic cylinder on its side with the couplers facing up.
3. Close the pump release valve (finger tight). Operate the pump to advance and retract the cylinder plunger three or four times.
4. Open pump release valve to retract the cylinder plunger. Check pump oil level. Add oil as necessary to restore correct level in the reservoir.

ADVANCING AND RETRACTING CYLINDER PLUNGER

1. To advance cylinder plunger, turn pump release valve clockwise as illustrated in Figure 7 and close **finger tight**.



To avoid release valve damage, do not use tools to tighten valve.

2. Operate pump handle.
3. To retract cylinder plunger, turn release valve counterclockwise as illustrated in Figure 7.
4. Pumps can be operated while they are horizontal or vertical as long as the hose end is down.

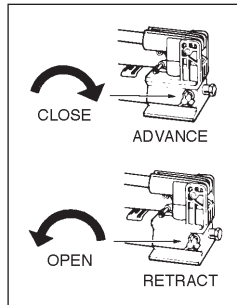

Figure 7
Release Valve Positions

MAINTENANCE

1. To check oil level in pump, open pump release valve to allow oil in cylinder (if connected) to return to pump.
2. Remove fill cap and add GB/ENERPAC hydraulic oil until level with mark on rear cap. **DO NOT** overfill. To function properly, all hand pumps require air in the reservoir. If oil level is too high, the pump will not operate.
3. If hydraulic system is used under extremely dirty conditions, frequently drain pump completely.
4. Refill with clean GB/ENERPAC hydraulic oil.
5. Install fill cap and close it.

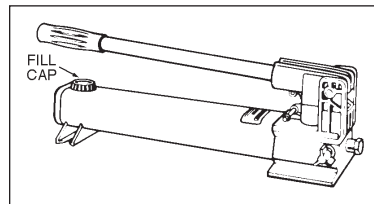

Figure 8
Location of Fill Valve

REPLACING COUPLERS

To assemble to hose:

1. Clamp the hexagon nut of the hose fitting in a vise as illustrated in Figure 9.
2. Remove the old coupler or rigid adapter.
3. Install the new coupler clockwise onto hose fitting to a firm fit. Use high quality thread sealer on threads (one wrap only).

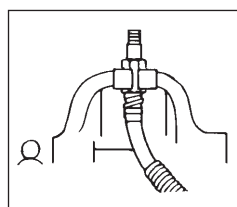

Figure 9
Assembling to Hose

A kit has been prepared for the purpose of replacing a worn out seal and may be obtained at your nearest GB Authorized Service Center.

To assemble Spee-D-Couplers to cylinder:

1. Use wrench to unscrew old coupler half from cylinder.
2. thread new coupler to cylinder and tighten firmly. Use a high quality thread sealer on coupler threads (one wrap only).

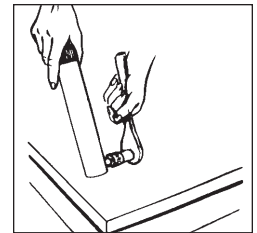

Figure 10
Assembling Couplers to Cylinder

HYDRAULIC CYLINDERS

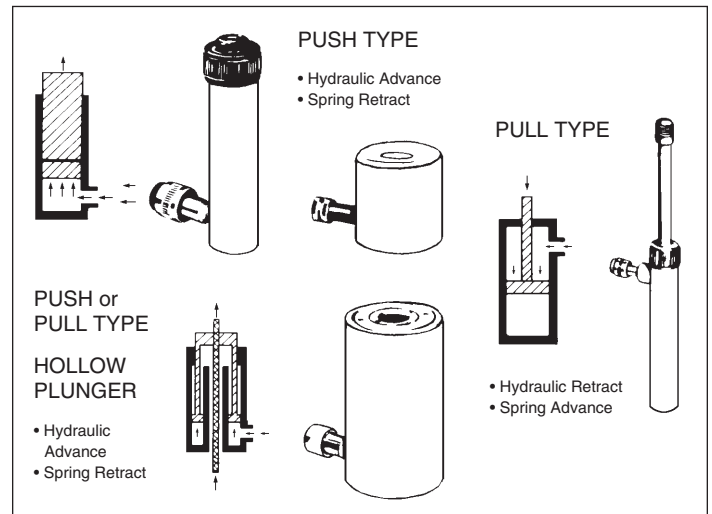

Figure 11
Single-Acting Hydraulic Cylinders

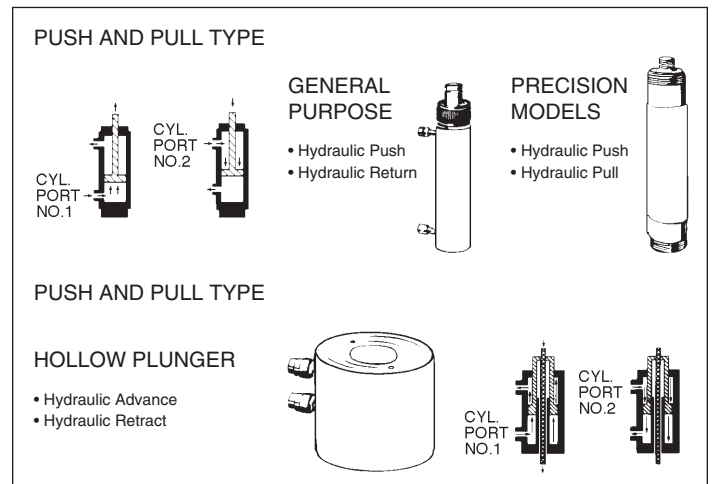

Figure 12
Double-Acting Hydraulic Cylinders

GENERAL INSTRUCTIONS

GB cylinders are designed for full rated capacity over the full plunger travel. Refer to current GB catalog for capacity.

OPERATIONAL INSTRUCTIONS

Hydraulic Connections – All hydraulic cylinders must be properly connected to the hydraulic pump to function. Always use thread sealer on connections; i.e., teflon tape or equivalent. Figures 13 and 14 show the basic connections of hydraulic cylinders to pumps.

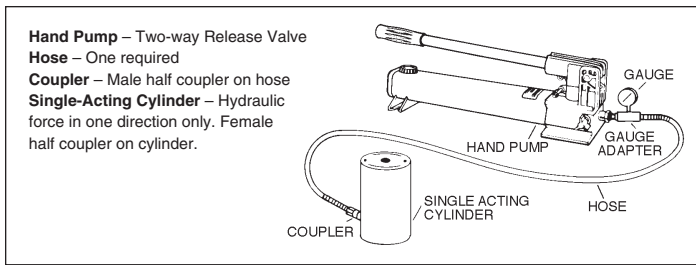

Figure 13
Connecting a Single-Acting Cylinder to a Hand Pump

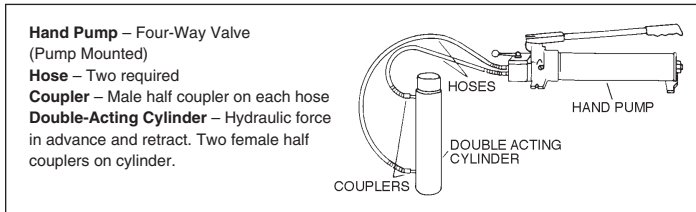

Figure 14
Connecting a Double-Acting Cylinder to a Hand Pump

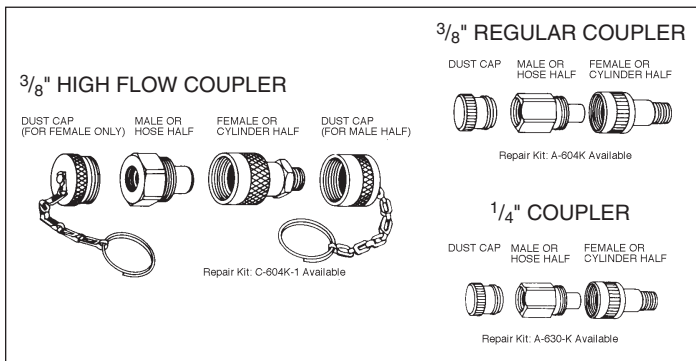

Figure 15
Couplers

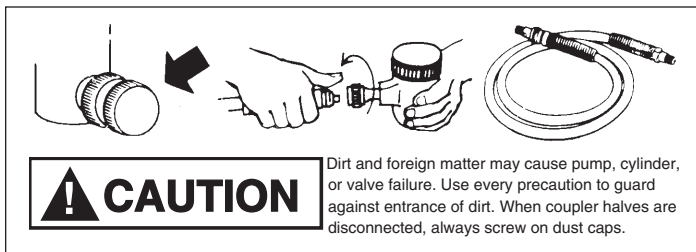

Figure 16
Keeping Oil Lines Clean

TROUBLESHOOTING

1. Advance the hydraulic cylinder into its fullest extension. If the cylinder does not fully advance, refer to Problems No. 1 and 2 below.
2. After the cylinder is advanced, continue to pump until the gauge shows approximately 3,000 PSI of hydraulic pressure. If 3,000 PSI cannot be obtained, refer to Problem No. 5 below.
3. After 3,000 PSI is obtained, put your hydraulic system into the hold position. If the pressure drops rapidly, refer to Problem No. 5 below.

PROBLEM	POSSIBLE CAUSE
1. Cylinder will not advance	A. Pump release valve open B. No oil in pump C. Air bound D. Couplers not fully tightened E. Blocked hydraulic line F. Pump not operating
2. Cylinder advances part way.	A. Oil level in pump is low B. Cylinder plunger binding C. Air trapped in cylinder
3. Cylinder advances in spurts	A. Air in hydraulic system B. Cylinder plunger binding
4. Cylinder advances slower than normal	A. Leaking connection B. Restricted hydraulic line or fitting C. Loose coupler D. Pump malfunctioning
5. Cylinder advances but will not hold pressure	A. Cylinder seals leaking B. Leaking connection C. Pump malfunctioning D. Incorrect system set-up
6. Cylinder leaks oil	A. Worn or damaged seals B. Loose connection C. Internal cylinder damage
7. Cylinder will not retract or retracts slower than normal	A. Pump release closed B. Coupler not fully closed C. Blocked hydraulic line D. Broken retraction spring E. Pump reservoir over-filled F. Cylinder damaged internally
8. Cylinder will not fully retract	A. Weak retraction spring B. Pump reservoir over-filled C. Partially blocked hydraulic line D. Damaged internally or externally

REPAIR AND SERVICE INSTRUCTIONS: For repair service and parts contact your nearest GARDNER BENDER Service Center. The Service Center will provide complete and prompt service on all GARDNER BENDER products.

PARTS AND SERVICE: For quality workmanship and genuine GARDNER BENDER parts, select an Authorized GB Service Center for your repair needs. Only repairs performed by an Authorized Service Center displaying the official GB Authorized sign are backed with full factory warranty. Contact GARDNER BENDER (414) 352-4160 for the name of the nearest GB Authorized Service Center.

WARRANTY: GARDNER BENDER warrants its products against defects in workmanship and materials for 1 year from date of delivery to user. Chain is not warranted. Warranty does not cover ordinary wear and tear, abuse, misuse, overloading, altered products or use of improper fluid.

WARRANTY RETURN PROCEDURE: When question of warranty claim arises, send the unit to the nearest GB Authorized Service Center for inspection, transportation prepaid. Furnish evidence of purchase date. If the claim comes under the terms of our warranty the Authorized Service Center will REPAIR OR REPLACE PARTS AFFECTED and return the unit prepaid.

GB
Gardner
Bender

6101 N. Baker Road, Milwaukee, WI 53209
Phone: (414) 352-4160 FAX (414) 352-2377

RPS-0070 0110